

Maxy Kart

- ⓕ Manuel d'instructions
- ⓖ Owners Manual
- ⓓ Gebrauchsanweisung
- Ⓡ Avvertenza per il montaggio e di utilizzazione
- ⓔ Instrucciones de montaje
- Ⓟ Nota da montagem e da utilização
- Ⓢ Bruksanvisning



BREVETÉ - PATENTED

- **Instructions de sécurité**

- **Instructions de montage**

Attention : merci de lire et de suivre toutes les instructions avant d'utiliser ce produit.

- **Important Safety Instructions**

- **Assembly Instructions**

Caution : read, understand and follow all instructions before using this product.

- **Sicherheitshinweise**

- **Montageanleitung**

Bitte beachten Sie : Die Anweisungen vor der Benutzung des Produktes zu lesen und zu befolgen.

- **Istruzioni di sicurezza**

- **Istruzioni di montaggio**

Attenzione : leggere e seguire tutte le istruzioni prima di utilizzare questo prodotto.

- **Instrucciones de seguridad importantes**

- **Instrucciones para el ensamblaje**

Atención : siga fielmente todas las instrucciones antes de utilizar este producto.

- **Instrução de segurança**

- **Instrução da montagem**

Atenção :Agradecemos que leia e de seguir todas as instruções antes da utilização deste produto.

- **Viktig säkerhets information**

- **Monterings anvisningar**

Observera : läs, förstå och följ alla instruktioner innan du använder denna produkt.

GARDEN Kart

 **CQFD**

Important Safety Instructions

1. Read all instructions carefully before use.
2. Do not allow children to use the dumping garden kart unsupervised. This dumping MAXY KART is not a toy
3. Do not load any items on the top edges of the plastic tray.
- 4 Do not operate or use on objects that can cause damage to the pneumatic tires or tubes. Do not inflate tires to more than the maximum PSI rating listed on the tires.
5. Save these instructions.

Assembly Instructions

Your dumping garden kart requires assembly. Account for all parts and hardware before beginning assembly. If any parts are missing or damaged, or if you have any questions or need any additional instructions.

Tools required for assembly : standard screwdriver and socket set (or two adjustable wrenches).

Step 1

Lay the main frame assembly on a flat working surface.



Step 2

Attach the front axle assembly to the main frame using the (4) main frame assembly bolts, washers and lock nuts. Attach the bolts on the steering link connector to the axles using the (2) steering link shoulder bolts, washers and lock nuts.

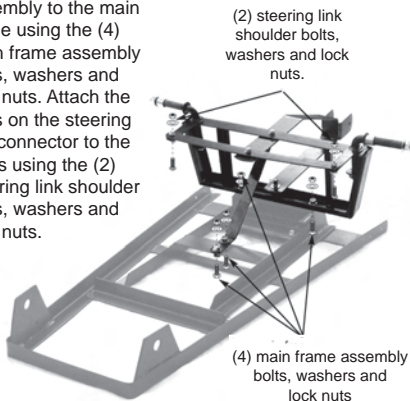

Step 3

Attach the axle and (2) 10" wheels to the main frame assembly. Slide the wheel spacer bushings onto the axle ends, insert the wheels and attach using the wheel washers and the cotter pins.



Step 4

Flip the cart over to the upright position. Attach the upright handle to the main frame assembly using the (4) upright handle bolts, washers and lock nuts provided.

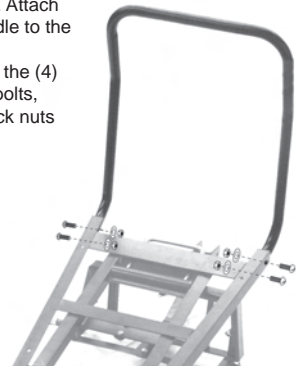

Step 5

Attach the (2) tray braces to the main frame assembly using (2) main frame assembly bolts, washers and lock nuts.

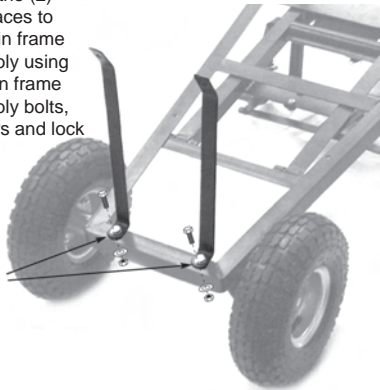
**Step 6**

Attach the tray to the main frame assembly using the (6) tray bolts, washers and lock nuts.

**Step 7**

Attach the (2) 13" wheels to the front axle assembly. Slide the wheel spacer bushings onto the axle ends, insert the wheels and attach using the wheel washers and wheel lock nuts.

**Step 8**

Attach the pull handle assembly to the front axle assembly using the pull handle bolt, washer and lock nut.









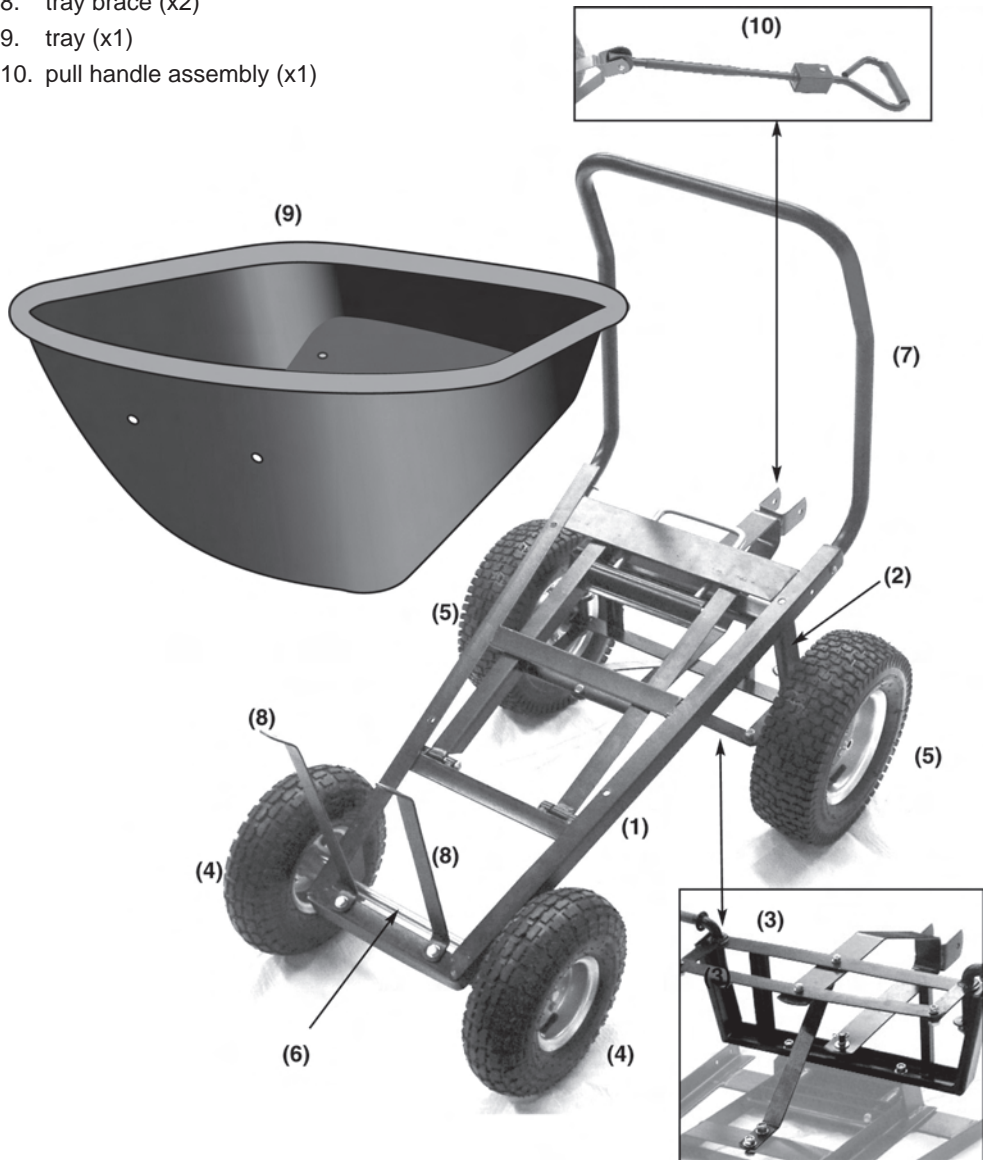









**CAUTION**

Do not exceed maximum overall load capacity 662 lbs.

Exploded drawing for assembly

1. main frame assembly (x1)
2. front axle assembly (x1)
3. steering link connector (x1)
4. 10" wheel (x2)
5. 13" wheel (x2)
6. axle (x1)
7. upright handle (x1)
8. tray brace (x2)
9. tray (x1)
10. pull handle assembly (x1)



	x 6	main frame assembly bolt
	x 6	main frame assembly washers
	x 6	main frame assembly lock nut
	x 2	steering link shoulder bolt
	x 2	steering link washer
	x 2	steering link lock nut
	x 2	wheel spacer bushing
	x 4	wheel washer
	x 4	cotter pin
	x 2	wheel lock nut
	x 2	upright handle bolt
	x 4	upright handle washer
	x 4	upright handle lock nut
	x 6	tray bolt
	x 6	tray washer
	x 6	tray lock nut
	x 1	pull handle bolt
	x 1	pull handle washer
	x 1	pull handle lock nut

Maxy *Kart*



GARDEN *Kart*

 **CQFD**

Z.I. Route de Ravel - 69440 ST-LAURENT-D'AGNY - FRANCE